

# Outdoor wall covering

04.08.2011



## **Foraas Områdesikring AS**

7491 Trondheim  
Tlf. sentr.bord: 46 83 50 00  
post@foraas.no  
www.foraas.no



## **TWINSON**

# **BEST OF BOTH WORLDS**

Welcome to the world of Twinson, where nature and technology go hand in hand.

Twinson is made of wood and PVC. By combining the advantages of both materials in a single new material, Twinson offers the **best of both worlds**: the **natural appearance** and **warm feel of wood**, and the **ease of maintenance** and **durability of PVC**. Twinson is 100% recyclable. What's more, with its PEFC certification, Twinson is an environmentally friendly alternative to tropical hardwood. While tropical hardwood is only available from endangered rain forests, Twinson contains wood that grows quickly in continuously replanted forests.

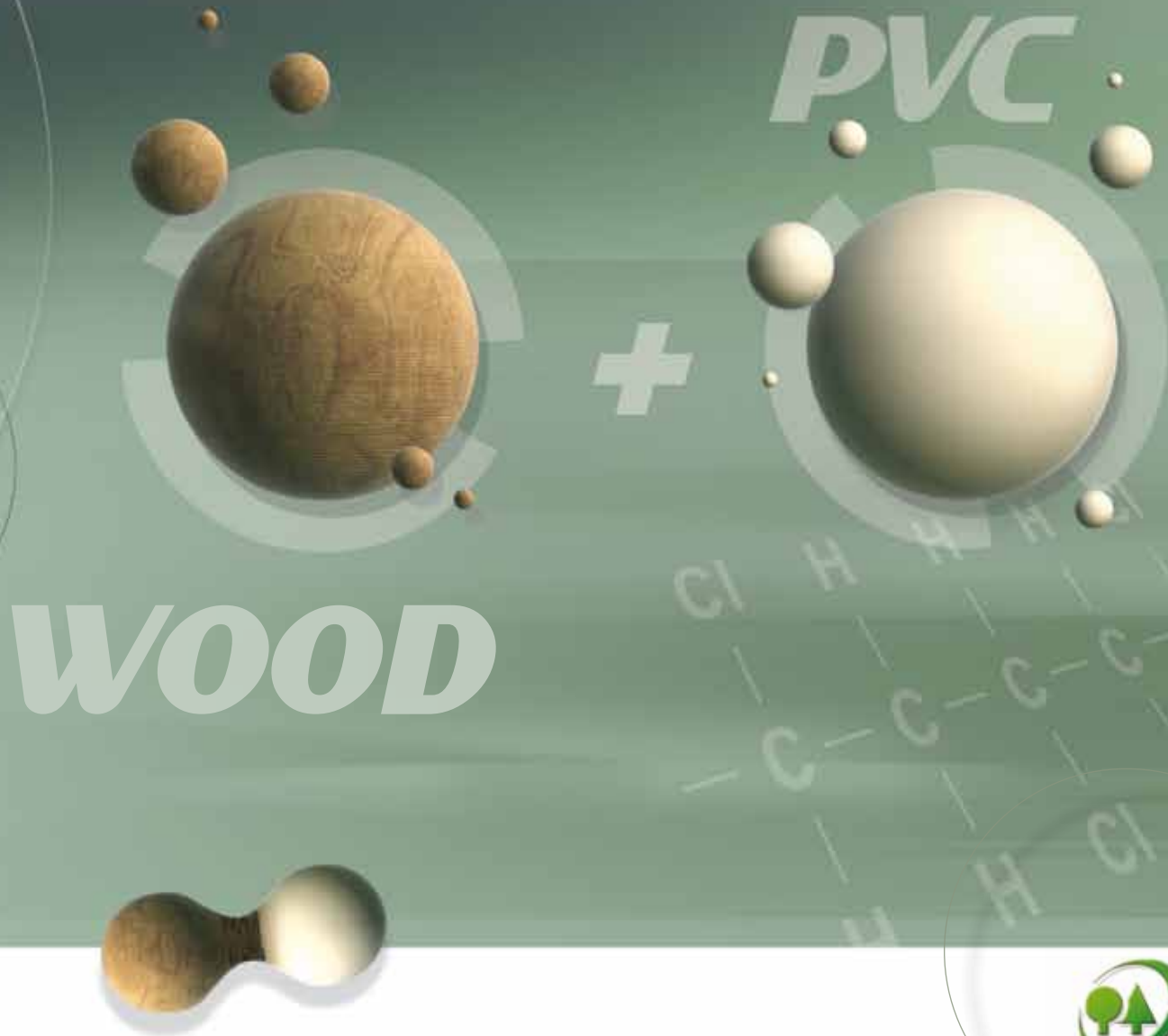

**TWINSON** combines all the advantages of wood and PVC:



- |   |                        |
|---|------------------------|
| ● <b>natural appearance</b>                         | ● low maintenance      |
| ● durable   | ● water resistant      |
| ● resistant to insects                              | ● does not split       |
| ● <b>environmentally friendly (100% recyclable)</b> | ● <b>splinter free</b> |
| ● <b>PEFC certified</b>                             |                        |

The general conditions with regard to warranty are applicable.

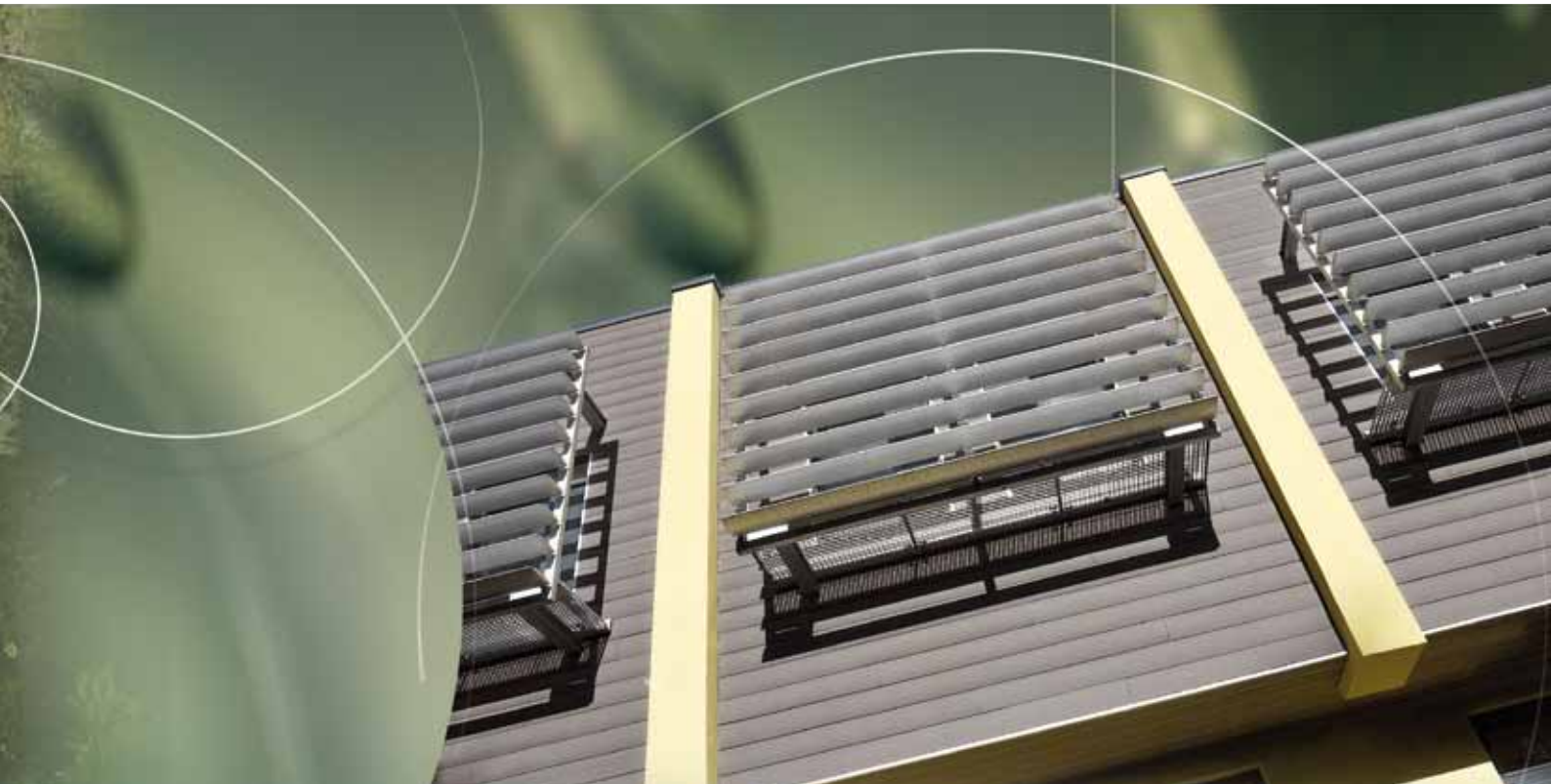

## THE BEAUTY OF NATURAL COLOURS

Twinson cladding profiles and finishing trims are available in 3 different natural colours. With Twinson, you can transform your house into a stylishly finished environment that you can enjoy for years to come.

502



LIQUORICE

504

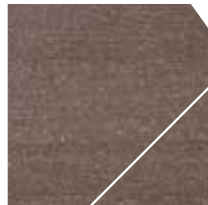

BARK

505



TURF

The colour samples are reproductions and can deviate from the originals. The large inset shows the natural colour which the O-Wall will change to over time. **Twinson contains wood fibres**, susceptible to differences in colour and appearance. As soon as the product is exposed to sun and rain, these fibres will undergo a **natural aging process** and will be subject to colour changes. After a couple of months, the final patina will be obtained. Planks should be mixed prior to installation to gain a natural effect.

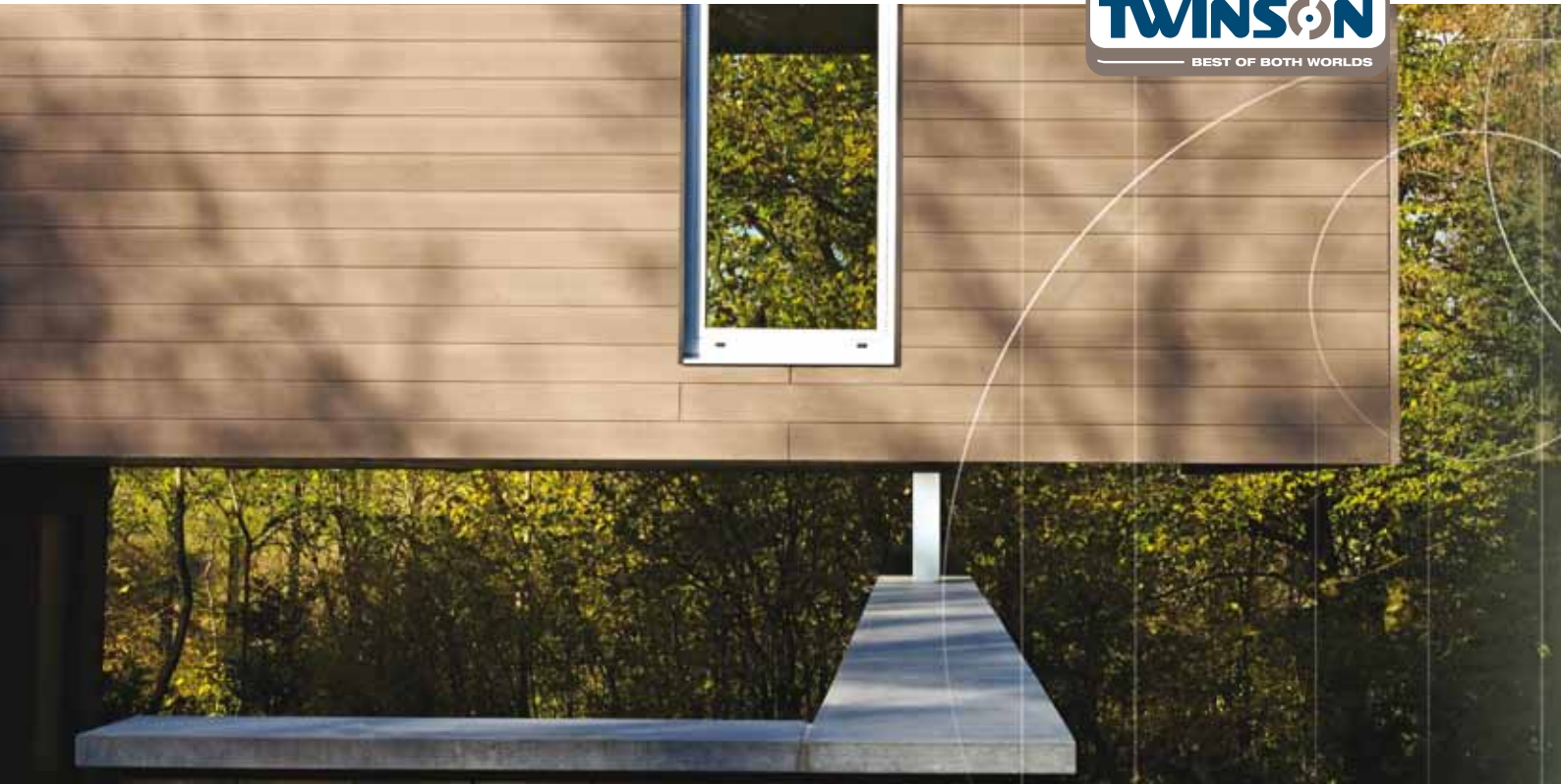

## CLOSED - WALL CLADDING SYSTEM

A building's appearance is determined in part by its facade. With Deceuninck Twinson O-Wall, **looks** and **functionality** go hand in hand. O-Wall outdoor wall covering can be part of a total **insulation concept** or **simply function as finish**. O-Wall covering is not only suitable for cladding outdoor walls, but also bay windows, dormers and eaves. The result is always a pleasure to behold.

- **Integrated ventilation:** With a ventilated - and thus breathing - outer wall, **air circulation** ensures the **efficient discharge of moisture and heat**, making possible a healthy indoor climate.
- **Can be combined perfectly with insulation:** Thanks to its limited thickness, O-Wall is suitable not only for new construction but also for renovations. A **well insulated** outdoor wall contributes to **lower heating costs** and reduced CO<sub>2</sub> emissions, for new constructions as well as renovations. Thus, it is an energy and cost-saving solution.
- **Quick and easy to install:** The tongue and groove system, and the specially developed patented concealed clips make it quick and easy to install the outdoor wall covering.
- **Simple to work with and process:** No special tools are needed for installing and processing the wall covering. **Standard tools are all that is needed.** O-Wall is available in 3 and 6-metre lengths.
- **Robust:** Exceptionally strong and robust thanks to its double-walled construction.
- **Down to the last detail:** For a perfect finish, a complete assortment of profiles has been created.
- **Unique material:** Thanks to Twinson's unique composition, O-Wall outdoor wall covering has all the advantages of the materials from which it is made: splinter free, durable, water resistant, natural look...

# ◉ - WALL

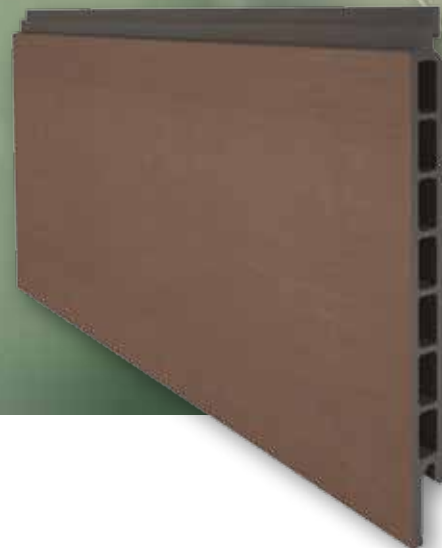

Extensive installation and processing instructions on [www.twinson.com](http://www.twinson.com)

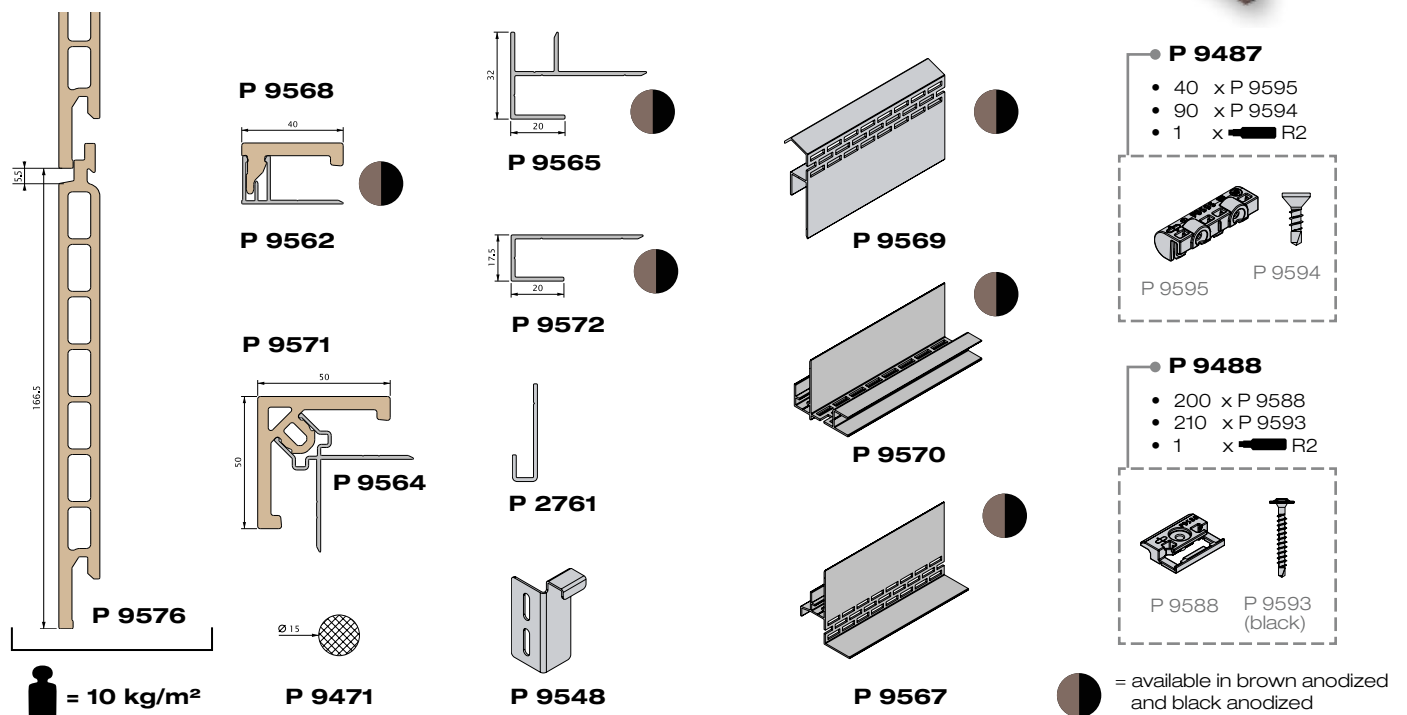

**- WALL**

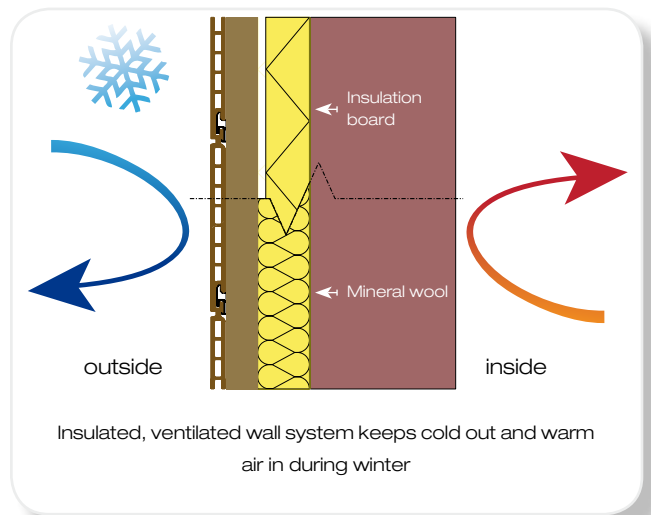
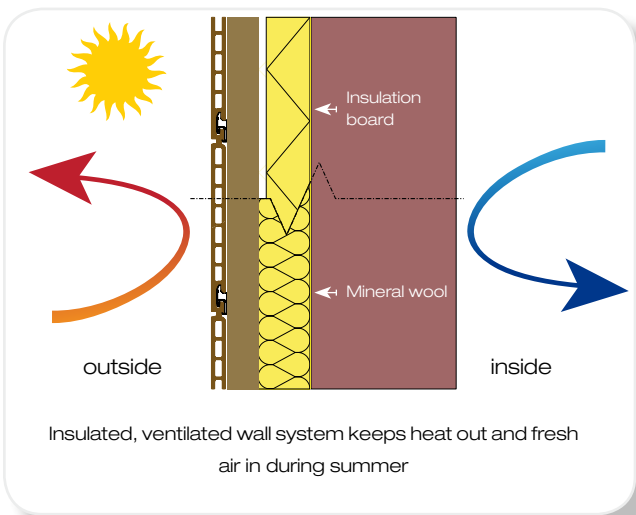



## OPEN WALL CLADDING SYSTEM

The Twinson open wall cladding system by Deceuninck works according to the open joint principle, and combines **aesthetics** with **functionality**. The underlying structure is made of high-quality anodised aluminium, ensuring very high durability. Not only can the cladding profiles be part of a **total insulation concept**, they can also be used **individually as finishing**. Like the Twinson O-Wall closed wall cladding system, the elements are not only suitable for cladding walls, but also for bay windows, dormers and eaves.

- **Integrated ventilation:**

Air circulation ensures that the open wall cladding system always **allows moisture and heat to escape**, thus contributing to a healthier climate in the home.

- **Perfect in combination with insulation:** thanks to its limited thickness, the Twinson open wall cladding system is suitable for both new construction and renovations. Good insulation results not only in lower heating costs but also in reduced CO<sub>2</sub> emissions. Hence, **the system is an economic and environmentally-friendly** solution. Since the open joint principle is used, a UV resistant, moisture-proof protection layer must be used.

- **Easy to install:** consistently beautiful results can be obtained with a minimum of profiles and material. Twinson P 9596 combines inspiration with freedom in design.

- **Simple to work with and treat:** like the closed wall cladding system, no special tools are needed to install and treat the outdoor wall cladding. **Standard tools are all that are needed.** The outdoor cladding elements are available in lengths of 3 metres.

- **Robust:** our Twinson outdoor wall cladding, as well as the underlying structure manufactured of high-quality anodised aluminium, offer very high durability, so you can continue to enjoy your outdoor wall cladding for years.

- **Unique benefits:** Twinson outdoor wall cladding of course also has all the benefits of Twinson itself: splinter free, durable, water resistant, and a natural look...

# OPEN CLADDING SYSTEM



Extensive installation and processing instructions on [www.twinson.com](http://www.twinson.com)

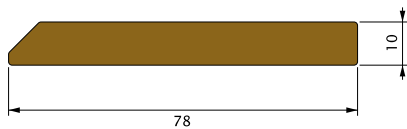

**P 9596**

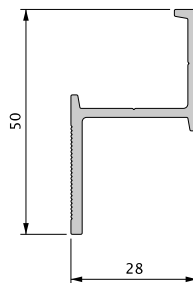

**P 9598**  
(black anodized)

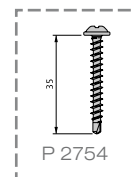

P 2754

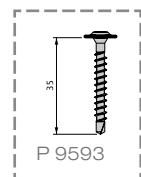

P 9593

- **P 2753**
  - 100x
  - 1 x R2
- **P 2754**
  - 1000x
  - 2 x R2

- **P 9593**
  - 210 x P 9593 (black)

# OPEN CLADDING SYSTEM

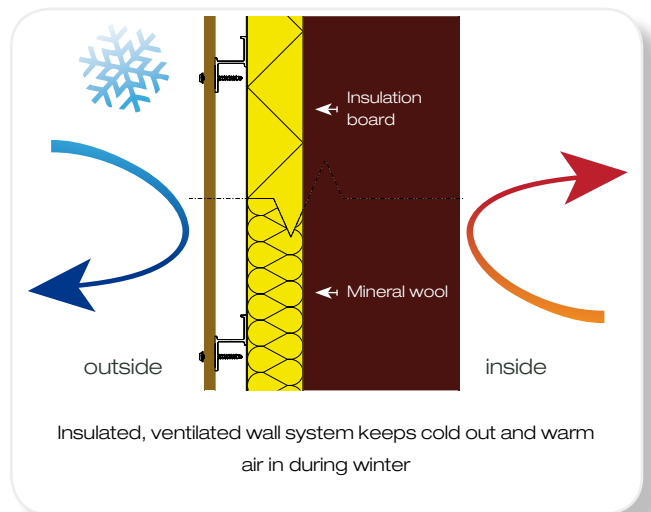
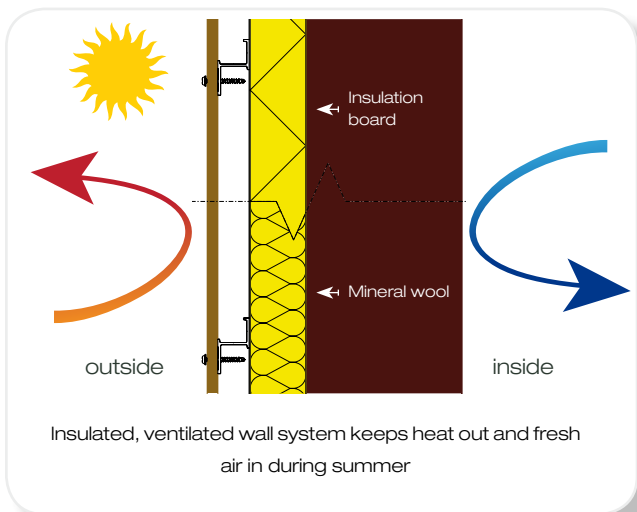

## **GUARANTEED ENVIRONMENTALLY FRIENDLY**

### **About PEFC**

The international non-profit organisation PEFC is dedicated to sustainable forest management. With more than 200 million hectares of certified forest, PEFC is the largest certification system in the world. PEFC ensures that **the number of trees harvested is not greater than the number replanted**, and that **biodiversity is retained**. Essential here is **respect for the natural habitat of fauna and flora, as well as for the soil and climate**.



### **Twinson and PEFC**

Twinson seamlessly makes the transition from tradition to innovation. The **ease of maintenance and durability of PVC** is combined with **the natural look & feel of wood**. Hence, Deceuninck is extremely proud that, thanks to a **thoroughgoing attention to sustainable production**, all innovative products based on Twinson technology receive this PEFC certificate. This certificate guarantees that the end-product contains only wood from a certified forest. Consequently, all the steps in the production process, from tree to end-product, are carefully monitored.

### **100% recyclable**

One of the most important environmental advantages of all Deceuninck products is that they are **guaranteed 100% recyclable**. Twinson is the perfect example of this. It is a unique material, made of fast-growing trees and PVC. All the material that remains at the end of the Twinson life cycle is collected and can be reused in new products **without loss of quality**.



## Foraas Områdesikring AS

7491 Trondheim  
Tlf. sentr.bord: 46 83 50 00  
post@foraas.no  
www.foraas.no



[www.twinson.com](http://www.twinson.com)

